



P/N: 15G065177000AK V1.0

# Quick Installation Guide PAUL / TOMMY



PAUL

TOMMY

Take note of the following precautions before you install server board components or change any server board settings.

1. Unplug the power cord from the wall socket before touching any components.
2. To avoid damaging the server board's components due to static electricity, NEVER place your server board directly on the carpet or the like. Also remember to use a grounded wrist strap or touch a safety grounded object before you handle the components.
3. Hold components by the edges and do not touch the ICs.
4. Whenever you uninstall any component, place it on a grounded anti-static pad or in the bag that comes with the component.

## 1 Install the PCIE Card

- 1 Remove the bracket facing the slot that you intend to use. Keep the screw for later use.
- 2 Align the card connector with the slot and press firmly until the card is completely seated on the slot.
- 3 Fasten the card to the chassis with the screw.

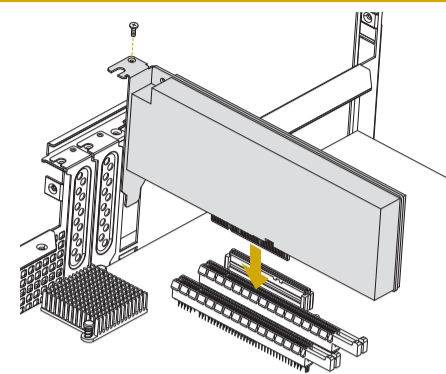

\*Images shown are for illustrative purposes only and may differ depending on model.

## 2 PCIE Card Layout

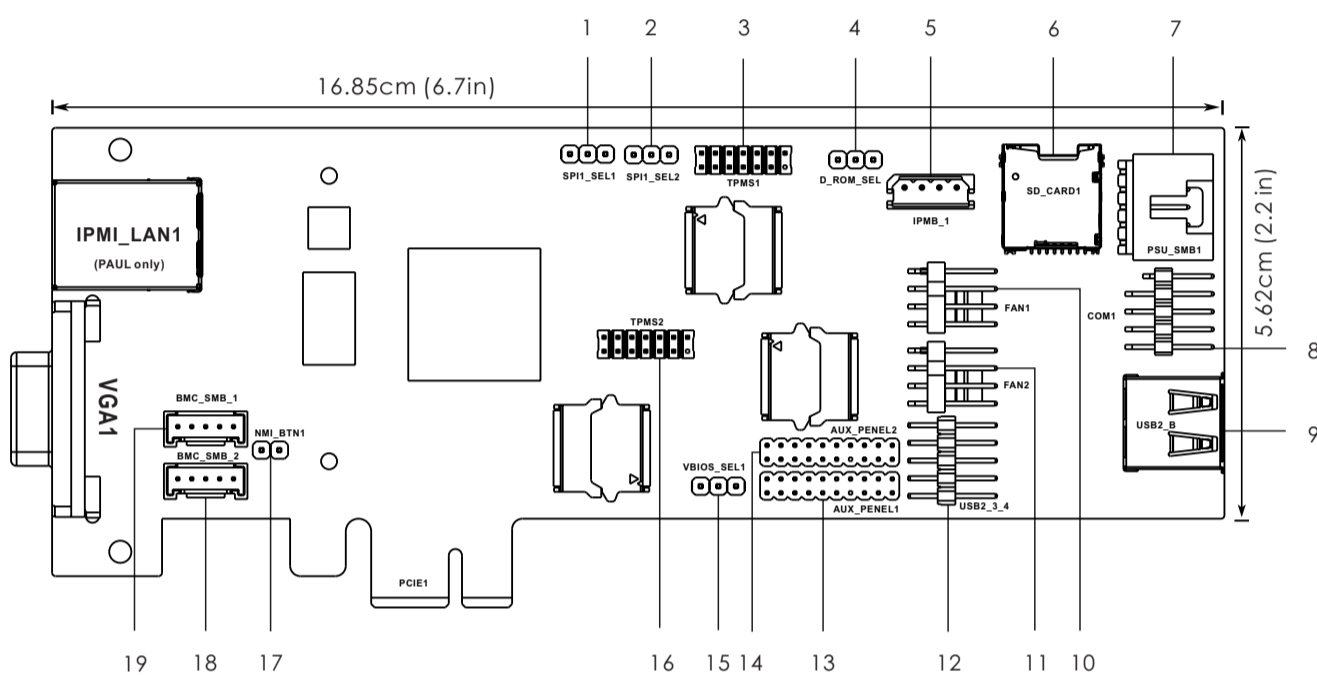

### No. Description

- 1 SPI Selection Jumper (SPI\_SEL1)
- 2 SPI Selection Jumper (SPI\_SEL2)
- 3 TPM Header (TPMS1) (PAUL only)
- 4 ROM Selection Jumper (D\_ROM\_SEL)
- 5 Intelligent Platform Management Bus Header (IPMB\_1) (PAUL only)
- 6 SD Card Slot (SD\_CARD1) (for PAUL only)
- 7 PSU SMBus (PSU\_SMB1) (for PAUL only)
- 8 COM Port Header (COM1) (for PAUL only)
- 9 USB 2.0 Type-A Port (USB2\_B) (for PAUL only)
- 10 System Fan Connector (FAN1) (for PAUL only)
- 11 System Fan Connector (FAN2) (for PAUL only)
- 12 USB 2.0 Header (USB2\_3\_4) (for PAUL only)
- 13 Auxiliary Panel Header (AUX\_PANEL1) (for PAUL only)
- 14 Auxiliary Panel Header (AUX\_PANEL2) (for PAUL only)
- 15 VBIOS Selection Jumper (VBIOS\_SEL1)
- 16 TPM Header (TPMS2) (for PAUL only)
- 17 Non Maskable Interrupt Button (NMI\_BTN1)
- 18 BMC SMBus Header (BMC\_SMB\_2) (for PAUL only)
- 19 BMC SMBus Header (BMC\_SMB\_1) (for PAUL only)

## 3 Jumper Settings

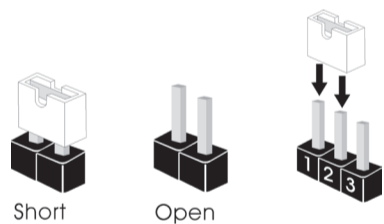

When the jumper cap is placed on the pins, the jumper is "Short". If no jumper cap is placed on the pins, the jumper is "Open".

The illustration shows a 3-pin jumper whose pin1 and pin2 are "Short" when a jumper cap is placed on these 2 pins.

Jumper	1-2	2-3
SPI_SEL1	for VBIOS	System BIOS
SPI_SEL2	(Default)	
D_ROM_SEL	1	(Default)
VBIOS_SEL	Merge in System BIOS (Default)	Dedicated to VBIOS

## 6 Headers

### TPMS1 (LPC) TPMS2 (TPM module)

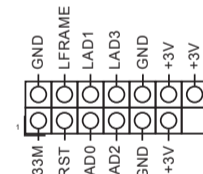

### IPMB\_1

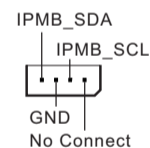

### PSU\_SMB1

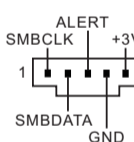

### COM1

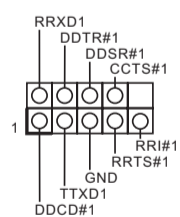

### AUX\_PANEL1



### AUX\_PANEL2

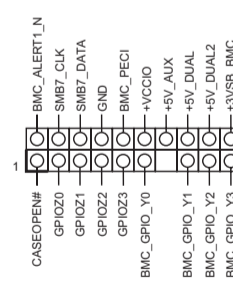

### FAN1 FAN2

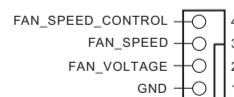

### BMC\_SMB\_1 BMC\_SMB\_2

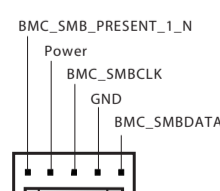

### USB2\_3\_4

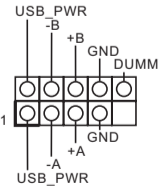

### NMI\_BTN1



## 4 I/O Panel

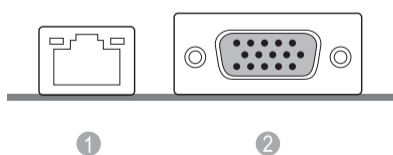

- | No. | Description                            |
|-----|--|
| 1   | LAN RJ-45 Port (IPMI_LAN1) (Paul only) |
| 2   | VGA Port (VGA1)                        |

## 5 LAN Port LED Indications

### IPMI LAN Port

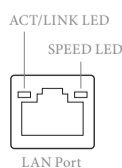

Activity / Link LED		Speed LED	
Status	Description	Status	Description
Off	No Link	Off	100M bps connection or no link
Blinking Yellow	Data Activity	Green	1G bps connection
On	Link		